

THIS COPY IS PROVIDED ON A RESTRICTED BASIS AND IS NOT TO BE USED IN ANY WAY DETRIMENTAL TO THE INTERESTS OF PANDUIT CORP.

Material	High Conductivity Seamless Copper Tube
Plating	Electro-Tin
Wire Size	350 STR/FLEX
Wire Type	Stranded Copper: Class G, H, I, K, M, Locomotive
Wire Strip Length	2-9/16 in.
Stud Size	3/8 in.
UL Listed Wire Connector	Yes, for applications up to 35kv. Consult cable manufacturer for voltage stress relief instructions with applications greater than 2000 volts.
UL Temperature Rating	90° C
C.S.A Certified Wire Connector	Yes
Panduit Color Code on Barrel	BLUE
Panduit Die Index No. on Barrel	P76
Alternate Industry Die Index No. ( ) on Barrel	(19)



CERTIFIED



LISTED Wire Connector

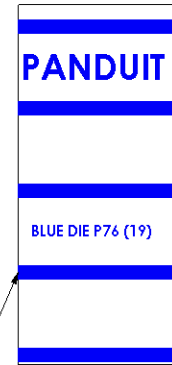
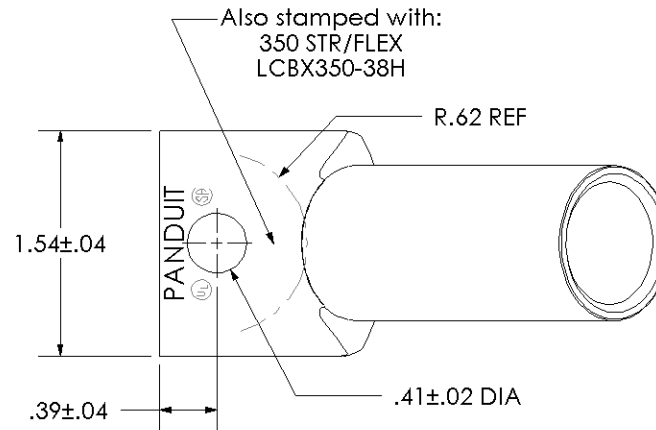

Color coded barrel markings

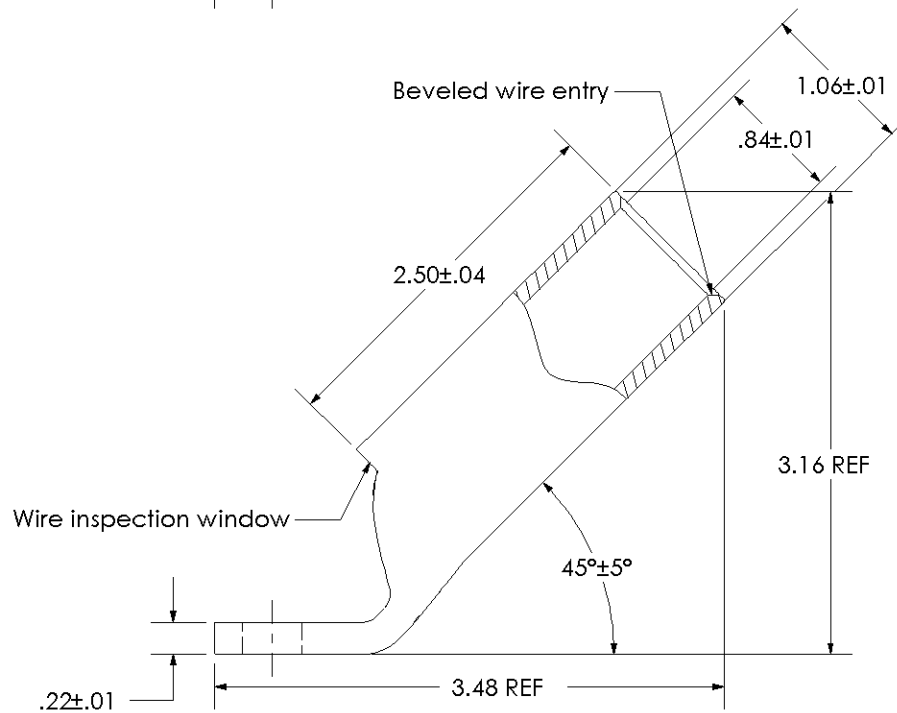

**PANDUIT CORP. TINLEY PARK, ILLINOIS**

LCBX350-38H-6  
Copper Lug - One-Hole, Long Flex Barrel, 45° Angle Tongue

00 6/03 SAC SAC

RELEASED

10850

REV DATE BY CHK

DESCRIPTION

ECN

SCALE  
N/A

DRAWING NO / CAD FILE

LCBX350-38H-CUST